

## INTRODUCTION

Thank you for buying a LumenRadio CRMX Nova product. This guide is intended to give you a quick start to experience the benefits of LumenRadio's CRMX system.

The CRMX products you just purchased are designed to give you the highest reliability on the market and are fully compatible with other CRMX products in entertainment lighting (CRMX Nova, CRMXOutdoor, CRMX Slim, CRMX OEM). Through this you are able to expand your wireless system with units from our other product lines as well as with those of our partners. For the latest updates please visit the LumenRadio website [www.lumenradio.com](http://www.lumenradio.com).

We hope that you will enjoy our products and that they will bring benefits and positive experiences.

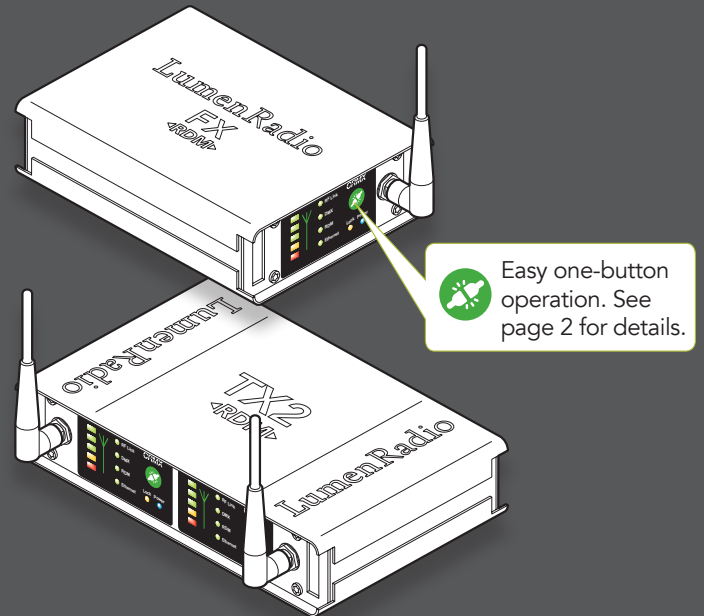

## CRMX NOVA CONTROL PANEL

See the operation section for details on how to link and unlink CRMX Nova units.

**Link button** - press to link with, or unlink from, another unit.

**Power** - on when power applied. **Lock** - Button lock is active on TX2 models.

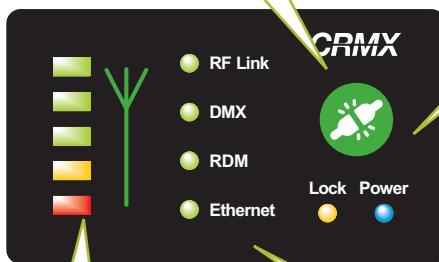

### Signal quality indicators

#### Transmitter:

Not used/All off.

#### Receiver:

Top green = 80% signal quality.  
Mid green = 60% signal quality.  
Bottom green = 40% signal quality.  
Amber = 20% signal quality.  
Red = Link problem.

### Status indicators

#### RF Link on Transmitter:

On = Normal operation.  
Fast flashing (~3Hz) = Linking.  
Slow flashing (~1Hz) = Unlinking.

#### RF Link on Receiver:

On = Linked with RF signal.  
Off = Unlinked.  
Fast flashing (~3Hz) = Linking or linked, but with lost RF signal.

**DMX:** On when DMX is present.

**RDM:** Flashes to RDM activity.

**Ethernet:** Flashes on Ethernet activity.

## CRMX NOVA OPERATION INDICATIONS

When operating, the CRMX Nova units show different indications depending on its mode and link status:

Transmitter (regardless of link status)

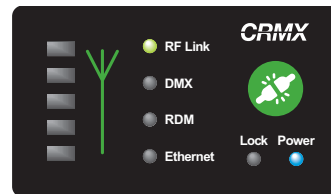

Receiver when not linked with a transmitter.

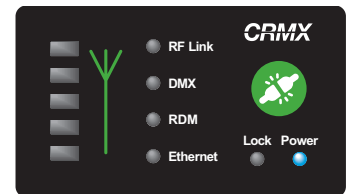

Receiver showing a healthy link with a transmitter.

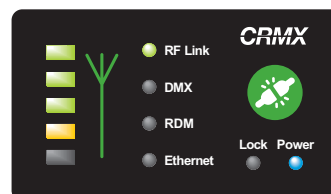

Receiver warning about a link problem.

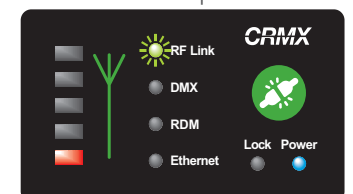

## NOTICE

### To optimize range and performance:

- Keep antennas upright
- Maintain TX to RX line of sight
- Elevate the units above any crowds
- Elevation above ground increases range
- Keep away from large metal objects



## LINKING

CRMX Nova units can link with any other CRMX units as well as legacy W-DMX™ (G2/G3/G4) transmitters (2.4 GHz only).

### TO LINK

1. Ensure the antenna is connected.
2. Power on the transmitter and receiver(s).
3. Ensure that the RF Link indicators on all receivers are off to indicate that the receiver(s) are ready to be linked. (If necessary, follow the unlink procedure.)
4. On the transmitter, press and release the  button.
5. The transmitter will search for any unlinked receivers. Its RF Link indicator will flash for 10 seconds and normal operation will resume.
6. The RF Link indicator will change to a steady on-state on successfully linked receivers.



### TO UNLINK



- **Unlink one:** On the receiver, press and hold its  button for more than 3 seconds to unlink it from a transmitter. The RF Link indicator will extinguish.
- **Unlink all:** On the transmitter, press and hold its  button for more than 3 seconds to unlink all of its receivers.

## FLEX MODE CHANGING (CRMX NOVA FX ONLY)



The CRMX Nova Flex unit offers the ultimate flexibility to operate as either a transmitter or a receiver. The CRMX Nova Flex unit is pre-configured as a **receiver**. The mode can be changed in either of two ways:

1. Using the SuperNova software. Please refer to the SuperNova website at [www.lumenradio.com/supernova](http://www.lumenradio.com/supernova) for more information.
2. Using a special button press sequence on the CRMX Nova Flex unit.

1. Press and release the  button five times in succession. Then immediately press and hold the  button for three seconds until the Lock and Power indicators begin alternately flashing. One of the signal quality indicators will be on:

-  Amber indicator on: Receiver mode selected
-  Red indicator on: Transmitter mode selected

2. You can now change the Flex mode as required. Note that the unit will automatically revert to normal operation fifteen seconds after you last pressed the button.

- To step between Flex modes: Press and release the  button to move to the next mode.
- To save changes: Press and hold the  button for three seconds. The unit will revert to normal operation using the newly selected mode.
- To exit without saving changes: The unit will revert to normal operation if you do not press the  button within fifteen seconds.

## SUPERNOVA

For configuration, management and monitoring of all CRMX units as well as RDM compatible devices, LumenRadio provides the software SuperNova free of charge. SuperNova is needed in order to configure network and port settings, manage frequency usage, etc.

SuperNova connects to any number of CRMX transmitters through Ethernet. For best performance, LumenRadio recommends using a network switch and straight through Ethernet cables. All CRMX units equipped with Ethernet are delivered with the following default network settings:

### UNIT FACTORY DEFAULTS

IP Address: 192.168.0.162  
Netmask: 255.255.255.0

SuperNova runs on any Windows, Mac OS X or GNU/Linux computer with a Java runtime environment of at least version 1.6. The latest version of SuperNova as well as detailed user guides can be accessed at [www.lumenradio.com/supernova](http://www.lumenradio.com/supernova).

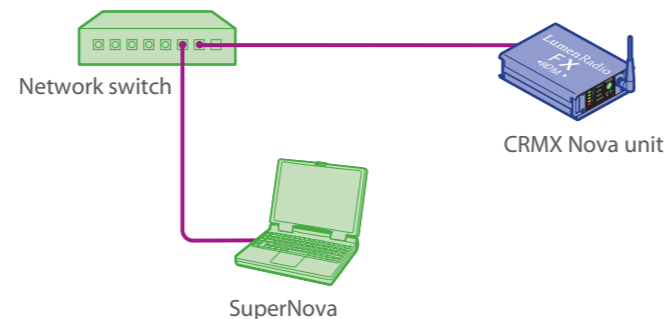

## REAR PANEL CONNECTIONS

### TX2-RDM™ TRANSMITTER UNITS

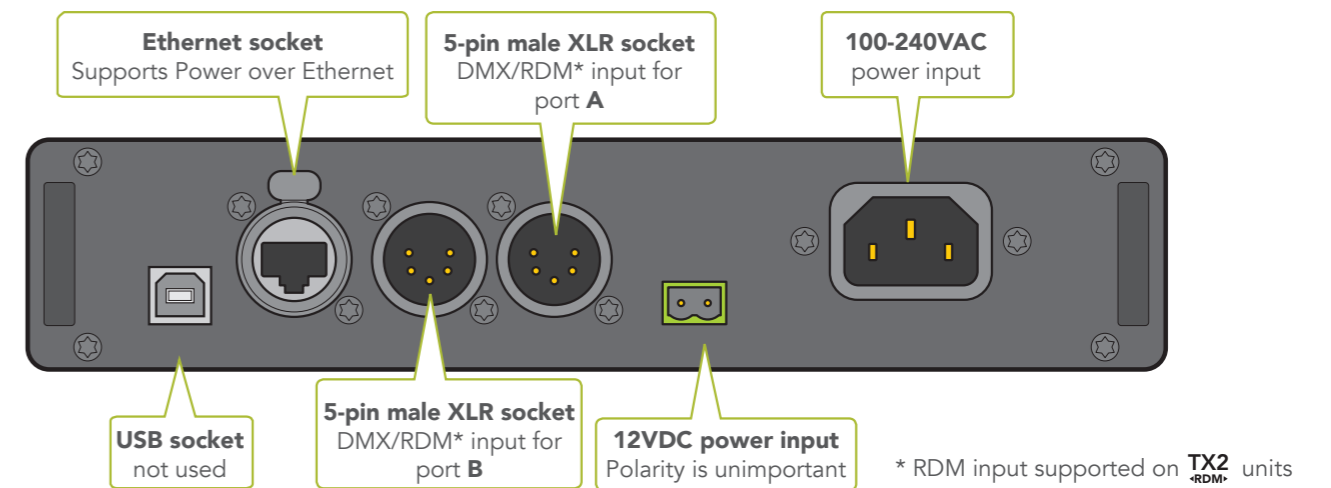

### TX TRANSMITTER UNIT

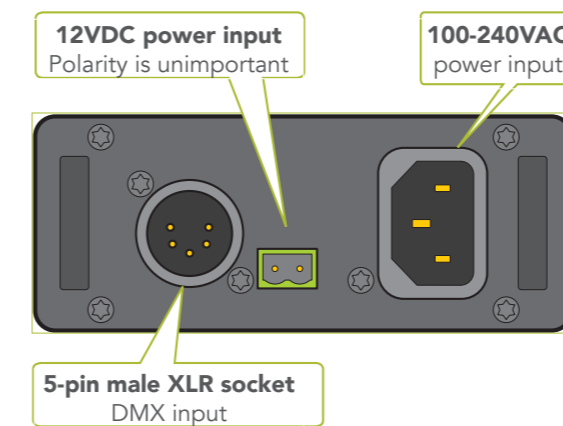

### RX AND RX-RDM™ RECEIVER UNITS

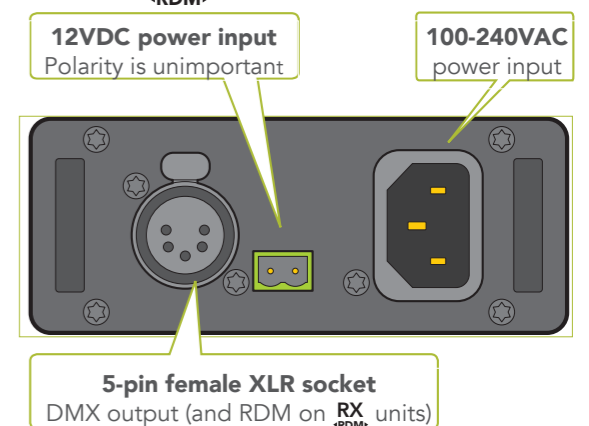

### FX-RDM™ FLEX TRANSMITTER/RECEIVER UNIT

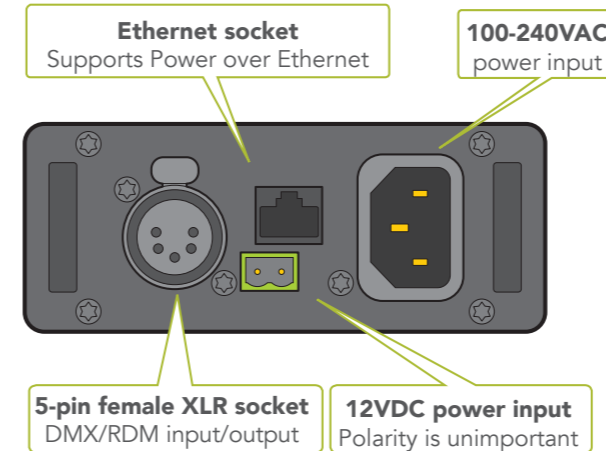

### POWER REQUIREMENTS

Please see the Specifications table on page 4 for details of power requirements for each model.

### WARNING

Use only one power source.

## ETHERNET NODE

The Ethernet enabled CRMX Nova units can act as Ethernet to DMX or DMX to Ethernet nodes for a multitude of Ethernet protocols. For specific instructions refer to the SuperNova user guides available at [www.lumenradio.com/supernova](http://www.lumenradio.com/supernova).

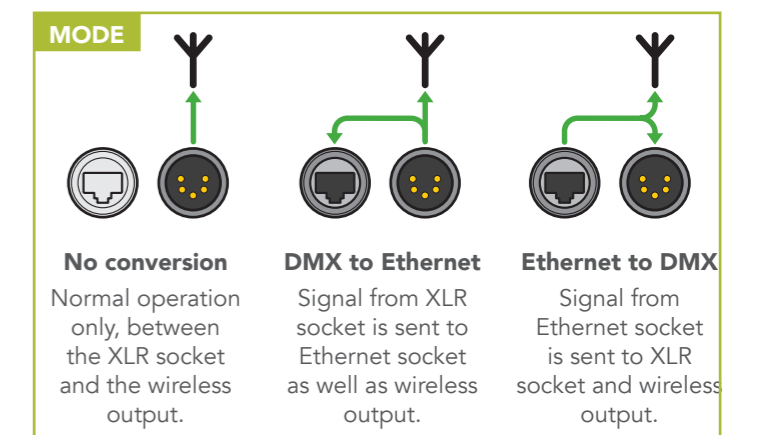

## MOUNTING

Each CRMX Nova unit is supplied with a M10 T-screw and nut to allow the unit to be securely fixed to any mounting point, such as trussing.

### TO USE A T-SCREW

1. Lower the T-screw into the slot on the side of the unit and then twist it clockwise to lock.
2. Place the nut onto the screw.
3. Turn the nut clockwise until it tightens across the slot, thus locking the T-screw securely within the slot.
4. You can now attach the unit to a secure mounting point.

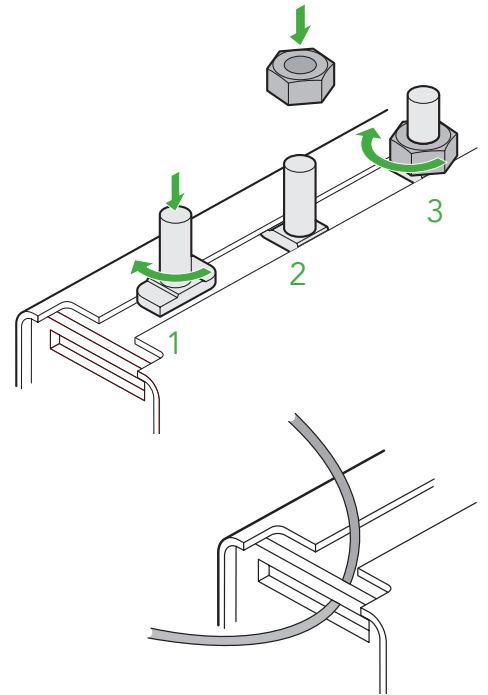

## SECURITY WIRE:

All CRMX Nova units have slots where a security wire can be attached. See illustration.

### FIRMWARE UPGRADE

All CRMX units are upgradeable. Please contact your local distributor for more information.

## SPECIFICATIONS

Power protection:	Overvoltage and ESD protected power input
Operation temp. range:	-20°C to +40°C (-4°F to 122°F) (ambient)
Environmental:	For indoor use only
Frequency range:	2.402 to 2.480 GHz
Output power levels:	300mW (25dBm) (Permitted only in North America), 100mW (20dBm), 35mW (15dBm), 10mW (10dBm)
PoE operation:	Equipment to be used in Network Environment 0 per IEC 62101. The PoE port is to be connected only to PoE networks without routing to the outside plant.
Low voltage operation:	This product can also be powered by a UL listed LPS power supply rated 12VDC, maximum 1A

### SPECIFICATIONS - MODEL DEPENDENT

Panel label	Power req. 100 - 240VAC <sup>1</sup>	Power req. 12VDC ± 20% <sup>2</sup>
<b>TX</b>	8W	8W
<b>RX</b>	8W	8W
<b>TX2</b> •RDM•	13W	13W
<b>RX</b> •RDM•	8W	8W
<b>FX</b> •RDM•	8W	8W

**TX2**  
•RDM• TX2 units contain a non-operator-access 1A 250VAC time-delay fuse. To be replaced by qualified service personnel only.

## FCC statement

Note: This equipment has been tested and found to comply with the limits for a Class B digital device, pursuant to part 15 of the FCC Rules. These limits are designed to provide reasonable protection against harmful interference in a residential installation. This equipment generates, uses and can radiate radio frequency energy and, if not installed and used in accordance with the instructions, may cause harmful interference to radio communications. However, there is no guarantee that interference will not occur in a particular installation. If this equipment does cause harmful interference to radio or television reception, which can be determined by turning the equipment off and on, the user is encouraged to try to correct the interference by one or more of the following measures:

- Reorient or relocate the receiving antenna.
- Increase the separation between the equipment and receiver.
- Connect the equipment into an outlet on a circuit different from that to which the receiver is connected.
- Consult the dealer or an experienced radio/TV technician for help.

## EU Declaration of Conformity

These products comply with the RED (Radio Equipment Directive) of the European Union (2014/53/EC). This equipment meets the following conformance standards:

ETSI EN 301 489-1 V2.1.1; ETSI EN 301 489-3 V2.1.1; ETSI EN 300 328 V2.2.1; EN 60950

For any questions, please contact  
[help@lumenradio.com](mailto:help@lumenradio.com) or visit  
<https://support.lumenradio.com>.

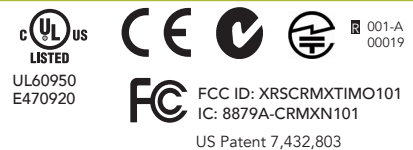

<sup>1</sup>UL approved for 115V +/- 10% operation

<sup>2</sup> May Only be used with UL class 2 certified power supplies

Release 8.0 May 2020

CRMX™, CRMX Nova™, CRMX Outdoor™, CRMX Slim™, CRMX OEM™, CRMX SuperNova™ are trademarks of LumenRadio AB. W-DMX™ is a trademark of Wireless Solution Sweden AB. CRMX is patented by LumenRadio, CE, FCC, ICES, SRRC and ARIB STD-T66 approved.